

Classe 300EOS with Netatmo touch screen handsfree video internal unit with Wi-Fi

344842


Description

2 wires/Wi-Fi handsfree connected video internal unit with built-in* Amazon Alexa® voice assistant, 5" vertical touch screen LCD display and video door entry answering machine.

It has a physical key for door lock release and capacitive keys for the control of the main video door entry functions: handsfree communication, entrance panel activation / camera scrolling and Favourite key (can be configured to activate the quick actions most frequently used – e.g. additional door locks, staircase light control, intercom). There are notification LEDs for: Wi-Fi network connection status, info / notifications and call exclusion.

It is possible to easily interact with the built-in Alexa® voice assistant, either using the dedicated capacitive keys or with your voice, and activate several functions, such as the video door entry functions, smart home, scenarios, reminders etc.

Using the touch display, it is possible to access the notification list, as well as your favourite door entry, security and Smart Home controls. The Home Page contains Smart Home function panels that allow to simultaneously control all the lights, shutters and fancoils of the house or individual rooms, to manage the thermostats and display the energy consumption of the home. Possibility of voice communication with the switchboard - if present in the system - after a specific call.

The device must be configured by physically connecting the configurators, or using the menu, which will give better possibilities of customisation of associated functions and texts. Thanks to the Wi-Fi connection, you can associate the video internal unit to the Home + Security App (available for Android and iOS). The App allows to use the main video internal unit functions (receiving calls, door lock release, display of the event timeline and activation of the entrance panel/camera cycling). With the Home + Security App, it is also possible to manage the products of the Netatmo Security range (outdoor and indoor cameras, door and window sensors, indoor siren, smoke detector). This allows you to quickly and easily create a Smart security system.

The device also allows to create and manage MyHOME BUS SCS solutions, without the need for adding dedicated gateways. The installer can configure the MyHOME system using the Home + Project app. Users can manage their homes: remotely with the Home + Control App, using the display interface and with Alexa® and Google® voice commands.

Wall mounted installation using the supplied bracket Possibility of Wi-Fi connection or using RJ45 ethernet cable with the dedicated accessory 344844.

(*) Alexa® is not available in all languages and all countries. The features and functions of Alexa® may vary depending on location.

Related items

- 344844 Accessory for connections using the ethernet cable RJ45
- 346020 Additional power supply

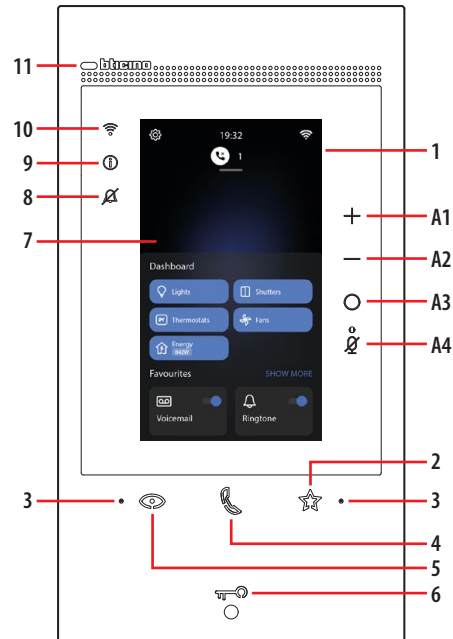
Technical data

Operating temperature:	5 – 40 °C
Power supply voltage from BUS-AV:	21 – 27 V
Additional power supply from 1-2:	27 V
Maximum BUS-AV absorption in operation:	580 mA
Maximum BUS-AV absorption when powered by clamp 1-2:	22 mA
Maximum cable section for each clamp:	2 x 1 mm ²
Maximum distance to be able to use Alexa®:	5 m in optimum ambient audio condition

Wireless device in compliance with 802.11b/g/n standard, supports 2.4 GHz Wi-Fi band; transmission power < 20 dBm. WEP/WPA/WPA2 safety protocol.

Minimum connection speed of 512 Kbps (0.51 Mbps) for streaming music and other content through Alexa®

Front view



Legend

1. 5" vertical touch screen display
2. "Favourites" touch key
3. Microphone
4. Touch key for answer
5. Entrance panel / scrolling activation touch key
6. Door release key
7. Home Page
8. Bell exclusion notification LED
9. Notification LED
10. Wi-Fi signal notification LED
11. Proximity sensor for future application

LED table

	flashing = incoming call. steady: communication in progress.
	flashing for 2 seconds: active "Safe Door Lock" function, deactivated key. flashing (sequence of 2 short flashing): Door open (*) or Professional Studio active. steady: communication in progress. steady for 2 seconds: door opening.
	flashing: ringtone excluded.
	yellow steady: notifications from Alexa®. white steady: answering machine messages.
	steady: forwarding of call, automatic switching on or "Call home" function in progress from Home + Security App. OFF: WI-FI disabled or working correctly. flashing: WI-FI on but not connected to the network.
	flashing at the same time: firmware update in progress.

(*) Only available with actuator 346260.

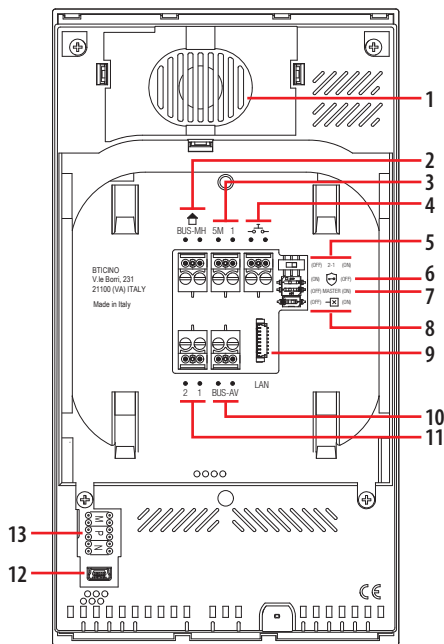
Alexa® control keys

A1	Key used to increase the volume.
A2	Key used to decrease the volume.
A3	Alexa® enabling key.
A4	"Mute" key, to disable both Alexa® and device microphone.

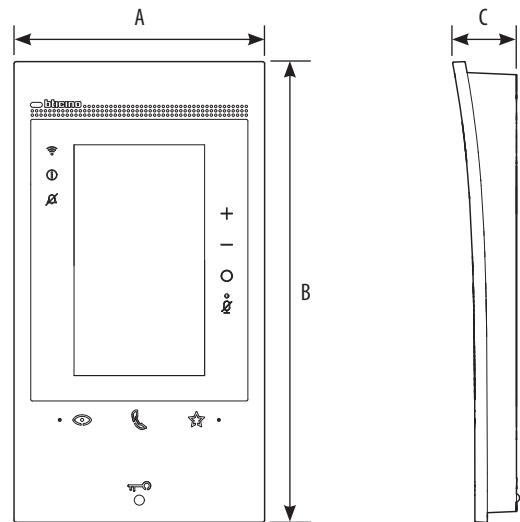
Note: once powered, the device takes up to 2 minutes to be available for use.



Rear view



Dimensional data



A	B	C
122 mm	222 mm	32 mm

Legend

1. Speaker
2. Clamps for connection to the BUS MH (MyHOME) (future application)
3. Additional bell connection clamps (5M – 1).
The connection must be point - point on the clamps of the additional bells
4. Clamps for the connection of an external call to the floor pushbutton
5. Micro-switch to enable the additional power supply *
6. Micro-switch for "Safe door lock" function *
7. Micro-switch for "Master" function *
8. Line termination micro-switch *
9. LAN connector
For connection using RJ45 cable, use accessory 344844 (not supplied)
10. Clamps for connection to the AV BUS (audio video)
11. Additional power supply clamps (2– 1)
12. Service USB interface
13. Configurator socket

* ON = enabled
 OFF = disabled

To activate the function with device not powered

Configuration

MyHOME Smart Home Configuration

The MyHOME Smart Home system must be configured using the Home + Project App available for mobile and desktop devices.

Home + Project makes it possible to design the entire system, configure all the associated devices and finally deliver the functioning system to the end customer (who will still have to complete the commissioning using the Home + Control App).

Home + Project can be downloaded from App Store



Download Home +Project App

or by logging on to <https://homeproject.legrand.com> site for the desktop version.

Video door entry system configuration using the menu

It is possible to configure the device using the appropriate menu (see the Installation and configuration manual).

Video door entry system physical configuration

Alternatively, it is also possible to use physical configurators as shown below.

M	P	N
⊙ ⊙	⊙ ⊙	⊙ ⊙
⊙ ⊙	⊙ ⊙	⊙ ⊙

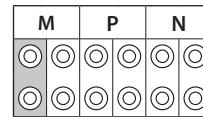
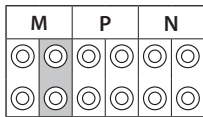
MM = Mode of operation according to the tables on the following pages.

PP = Address of the EP of which you can open the Door Lock with Handset idle, and to which you can send the auto-on command.

NN = Device address.



Physical configuration



The functions that can be attributed to the Preferred key (★) using the physical procedure configurator inserted in the MM - (units) socket are the following:

The MM (tens) physical configurator defines which 4 actions can be completed from the EDIT FAVORITES menu. The possible configurations are shown in the following table.

MM = 0	Staircase Light Control
MM = 1	Direct control of P+1 Door lock
MM = 2	Direct control of P+2 Door lock
MM = 3	Direct control of P+3 Door lock
MM = 4	P+1 direct auto-switching on
MM = 5	P+2 direct auto-switching on
MM = 6	P+3 direct auto-switching on
MM = 7	Paging
MM = 8	Internal intercom
MM = 9	Enabling/disabling Office function

LEGEND

	Activating the EP (configured with P+1) directly without the call or activating actuator 346210 (configured with P+1 and MOD=9)
	Door lock opening of EP (configured with P+1) directly without the call or activating the actuator 346210 (configured with P+1 and MOD=5) or activating the actuator 346230 (configured with P+1)
	Door lock opening of EP (configured with P+2) directly without the call or activating the actuator (configured with P+2 and MOD=5) or activating the actuator 346230 (configured with P+2)
	Door lock opening of EP (configured with P+3) directly without the call or activating the actuator 346210 (configured with P+3 and MOD=5) or activating the actuator 346230 (configured with P+3)
	Door lock opening of EP (configured with P+4) directly without the call or activating the actuator 346210 (configured with P+4 and MOD=5) or activating the actuator 346230 (configured with P+4)
	Intercommunicability between apartments in systems with apartment interface 346850
	Intercommunicability inside an apartment in systems with apartment interface 346850 or intercommunicability between apartments in systems without apartment interface
	Intercom on itself, sends the call to all the devices with the same address
	Paging, it makes general intercom and sends a call to all the handsets of the system







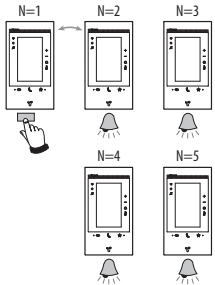
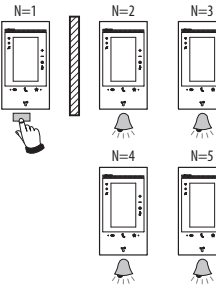
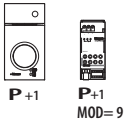
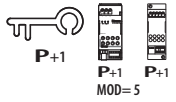
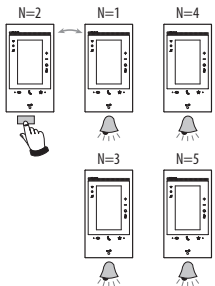
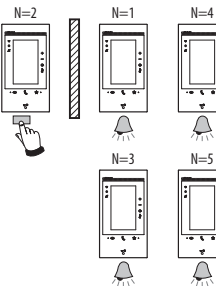
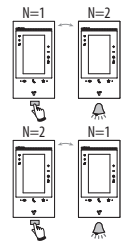
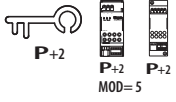
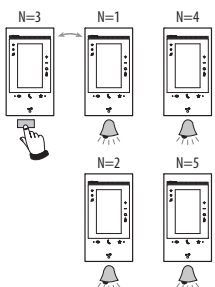
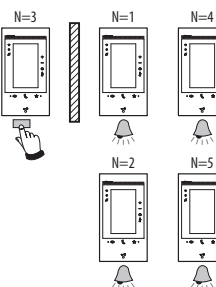
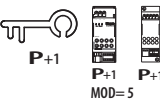
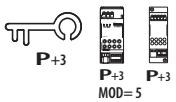
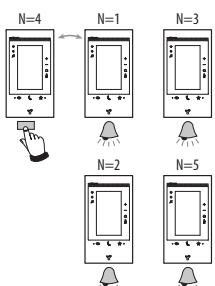
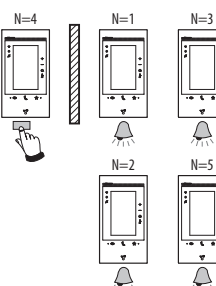
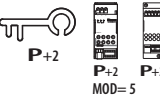
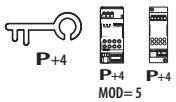
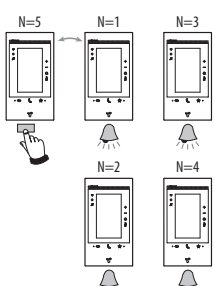
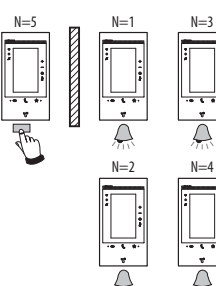
MOD = MM

<p>P+1 P+1 MOD=9</p>	<p>P+1 P+1 MOD=9</p>			
<p>P+1 P+1 P+1 MOD=5</p>	<p>P+1 P+1 P+1 MOD=5</p>	<p>P+1 P+1 MOD=9</p>		
<p>P+2 P+2 P+2 MOD=5</p>	<p>P+2 P+2 P+2 MOD=5</p>	<p>P+1 P+1 P+1 MOD=5</p>	<p>P+1 P+1 P+1 MOD=5</p>	<p>P+1 P+1 P+1 MOD=5</p>

When configuring the device, wait one minute before connecting it to the system again.



MOD = MM

When configuring the device, wait one minute before connecting it to the system again.

Classe 300EOS with Netatmo touch screen handsfree video internal unit with Wi-Fi

344842



Maximum distances and cable features

CAUTION: The use of conductors with characteristics other than the prescribed ones does NOT guarantee correct performance of the system and good quality of the video signal.

Single family video systems made only with Classe 100 and Classe 300EOS with Netatmo Internal Units

Cable section mm ²	2 normal cables > 0.2 mm ²	Bticino cable 336904 0.5 mm ²	Telephone twisted pair 0.28 mm ²	Bticino cable C9881U/5E AWG24 cable or UTP5 cable	Bticino cable 336904/336905 0.5 mm ²	One PT 278 TP 0.28 mm ²	OneSYT +Digital TP 5/10	OneSYT +Num TP 5/10	GIGA TW CAT5E AWG24	OneSYT +Num TP 8/10	Cable ARB.6060-1 6/10	Cable EV6R 6/10	1 mm ²
Max. distance Entrance Panel - Internal Unit	50 m	140 m	145 m	200 m	200 m	200 m	145 m	200 m	50 m	200 m	50 m	-	-
Max. distance Entrance Panel - Power supply	50 m	115 m	80 m	200 m	115 m	80 m	80 m	200 m	50 m	200 m	50 m	-	-
Max. distance Power supply - Internal Unit	25 m	50 m	30 m	110 m (*)	50 m	30 m	30 m	110 m	25 m	110 m	25 m	-	-
Max. distance Entrance Panel - Door lock	30 m	30 m	-	50 m	30 m	-	-	-	-	-	-	-	100 m

(*) Note: if it is locally supplied 200 m.

- In systems where the EP is replaced by apartment interface 346850, and where the distance Entrance Panel - Power Supply is less than 1 m, the distance Power Supply - Internal Unit can reach the maximum distance of 200 m when using the 336904/336905 cable.

Multi-family video systems made only with Classe 100 and Classe 300EOS with Netatmo Internal Units

Max. distance Entrance Panel - Furthest Internal Unit

Cable section mm ²	2 normal cables > 0.2 mm ²	Bticino cable 336904/336905 0.5 mm ²	Telephone twisted pair 0.28 mm ²	A pair of the multi-pair data cable CAT5
2 IU/2 pushbuttons	50 m	200 m	140 m	180 m
5 IU/5 pushbuttons	50 m	200 m	140 m	155 m
10 IU/10 pushbuttons	50 m	200 m	140 m	145 m
26 IU/26 pushbuttons	50 m	200 m	140 m	125 m
38 IU/38 pushbuttons	50 m	200 m	140 m	110 m
38 IU/ display call	50 m	200 m	140 m	115 m
64 IU/ display call	50 m	200 m	140 m	-

Max. distance Entrance Panel - Power supply

Cable section mm ²	2 normal cables > 0.2 mm ² or L4669	Bticino cable 336904/336905 0.5 mm ²	Telephone twisted pair 0.28 mm ²	A pair of the multi-pair data cable CAT5
2 pushbuttons	50 m	200 m	130 m	95 m
5 pushbuttons	50 m	190 m	120 m	85 m
10 pushbuttons	50 m	180 m	110 m	80 m
26 pushbuttons	50 m	150 m	100 m	70 m
38 pushbuttons	50 m	140 m	90 m	65 m
Display call	50 m	150 m	95 m	65 m

Max. distance Power Supply - Furthest Internal Unit

Cable section mm ²	2 normal cables > 0.2 mm ²	Bticino cable 336904/336905 0.5 mm ²	Telephone twisted pair 0.28 mm ²	A pair of the multi-pair data cable CAT5
5 IU (SHUNTED)	50 m	200 m	140 m	95 m
10 IU (SHUNTED)	50 m	200 m	140 m	95 m
26 IU (SHUNTED)	50 m	200 m	140 m	95 m
38 IU (SHUNTED)	50 m	200 m	140 m	95 m
64 IU (SHUNTED)	-	200 m	140 m	95 m

Max. distance Entrance Panel - Door lock

Cable section mm ²	0.28 mm ²	Bticino cable L4669 0.35 mm ²	Bticino cable 336904/336905 0.5 mm ²	1 mm ²
(S+/S-) clamps	30 m	30 m	50 m	100 m

- Risers with max 26 internal units should be made in systems with more than 26 internal units

- Classe 300EOS with Netatmo always with additional power supply 1-2

- To ensure the correct operation of the system, we recommend the use of the YouDiagram software, which can be downloaded free of charge from www.professionisti.bticino.it



Light and Automation Devices that can be directly associated via Classe 300EOS with Netatmo

Description	Legrand code	From production batch:	BTicino code	From production batch:
Scenario control	LG-573902	08W51	BT-L4680	09W08
	LG-573903	08W51	BT-N4680	09W08
	LG-574503	all	BT-NT4680	09W08
	LG-574504	all	BT-HC4680	09W08
	LG-067217	all	BT-HD4680	09W08
	LG-067218	all	BT-HS4680	09W08
	LG-078478	all		
LG-079178	all			
SCS/SCS interface	LG-003562	12W20	BT-F422	12W20
Touch multifunction control	LG-067243	13W05		
	LG-067244	13W05		
	LG-067245	13W05		
BUS 8-key control	LG-067592	all	BT-LN4652	all
			BT-H4652	all
2 m basic control	LG-067552	all	AR-64360	09W40
			BT-H4652/2	09W40
			BT-L4652/2	09W40
			BT-AM5832/22	09W40
3 m basic control	LG-067554	all	BT-L4652/3	09W40
			BT-H4652/3	09W40
			BT-AM5832/3	09W40
Light actuator			BT-K8002L	all
BUS shutter actuator	LG-067557	all	BT-LN4661M2	all
			BT-H4661M2	all
			BT-AM5861M2	all
			BT-K8002S	all
BUS shutter control	LG-067558	all	BT-LN4660M2	all
			BT-H4660M2	all
			BT-AM5860M2	all
Special control	LG-067553	all	AR-64362	all
			BT-L4651M2	08W41
			BT-H4651M2	08W41
			BT-AM5831M2	08W41
16A 100/240V 1 relay DIN actuator	LG-003847	all	BT-F411U1	all
16A 100/240V 2 relay DIN actuator	LG-003848	all	BT-F411U2	all
16A 100/240V 1 relay DIN actuator	LG-003841	10W17	BT-F411/1N	09W13
16A 2 relay DIN actuator	LG-003842	10W18**	BT-F411/2	09W04**
16A 100/240V 2 relay DIN actuator	LG-002601	all	BT-BMSW1002	all
16A 100/240V 4 relay DIN actuator	LG-002602	all	BT-BMSW1003	all
6A 4 relay DIN actuator	LG-003844	10W22*	BT-F411/4	09W04*
16A 100/240V 4 relay DIN actuator	LG-002604	all	BT-BMSW1005	all
4 output DIN actuator for 0-10V ballast	LG-002612	all	BT-BMDI1002	all
DIN actuator for 0-10V ballast	LG-003656	10W05	BT-F413N	09W14
Basic contact interface	LG-573996	10W04	BT-3477	10W04
DIN contact interface	LG-003553	10W13	BT-F428	09W50

* If the device is installed on the output of the F422 interface, the minimum batch is 15W25

** If the device is installed on the output of the F422 interface, it is not possible to associate it using the APP. It is recommended to replace it with the code F411U2

**Classe 300EOS with Netatmo
touch screen handsfree video internal unit
with Wi-Fi**

344842



Description	Legrand code	From production batch:	BTicino code	From production batch:
1000 VA DIN dimmer	LG-002621	all	BT-F416U1	all
1000 W DIN dimmer	LG-003652	09W50	BT-F414	09W29
400 VA DIN dimmer	LG-003653	10W07	BT-F415	09W22
2 x 400 VA DIN dimmer	LG-002622	all	BT-F417U2	all
300 VA DIN dimmer	LG-003665	all	BT-F418	all
2 x 300 VA DIN dimmer	LG-003651	all	BT-F418U2	all
LG-573912 3 m touch control	LG-573912	11W27	BT-HC4657M3	11W09
	LG-573913	11W09	BT-HD4657M3	11W12
			BT-HS4657M3	11W12
4 m touch control			BT-HC4657M4	11W12
			BT-HD4657M4	11W12
			BT-HS4657M4	11W14
SCS/DALI interface	LG-002631	10W13	BT-F429	10W20
Basic actuator			BT-3475	12W31
BUS shutter DIN actuator	LG-003666	all	BT-F401	all
Control actuator	LG-067561	all	BT-AM5852M2	all
	AR-64195	all	BT-H4672M2	all
	AR-64196	all	BT-LN4672M2	all
	AR-64393	all		
Basic control actuator			BT-3476	12W39
Control actuator	LG-067556	all	BT-LN4671M2	all
DIN dimmer for 0-10 V ballast	LG-002611	all	BT-BMDI1001	all
BUS Dual Tech Green Switch	LG-067226	all	BT-L4658N	all
	LG-078486	all	BT-N4658N	all
	LG-574048	all	BT-NT4658N	all
	LG-574098	all	BT-HC4658	all
			BT-HD4658	all
BT-HS4658	all			
PIR BUS automatic switch	LG-067225	all	BT-L4659N	all
	LG-078485	all	BT-N4659N	all
	LG-574046	all	BT-NT4659N	all
	LG-574096	all	BT-HC4659	all
			BT-HD4659	all
BT-HS4659			all	
PIR ceiling mounted sensor	LG-048820	all	BT-BMSE3001	all
PIR+US double technology ceiling mounted sensor	LG-048822	all	BT-BMSE3003	all
IP55 PIR wall mounted sensor	LG-048834	all		
Memory module			BT-F425	10W01
Control			BT-K4652M2	all
			BT-K4652M3	all
Control actuator			BT-K4672M2S	all
			BT-K4672M2L	all



Temperature Control Devices that can be directly associated via MyHOME Server

Description	Legrand code	From production batch:	BTicino code	From production batch:
Thermostat with Display	LG-067459	all	BT-LN4691	all
	LG-064170	all	BT-H4691	all
	LG-752131	all		
	LG-752731	all		
Temperature control probe			BT-KM4691	all
			BT-KG4691	all
			BT-KW4691	all
Probe without adjustment	LG-067458	13W36	BT-L4693	13W36
	LG-573924	13W36	BT-N4693	13W36
	LG-573925	13W36	BT-NT4693	13W36
			BT-HC4693	13W36
			BT-HS4693	13W36
			BT-HD4693	13W36
DIN actuator with 2 independent relays	LG-003579	13W06	BT-F430/2	13W06
DIN actuator with 4 independent relays	LG-003580	13W06	BT-F430/4	13W06
DIN actuator with 8 independent relays	LG-003517	all	BT-F430R8	all
DIN actuator with 2 0-10 V outputs	LG-003518	all	BT-F430V10	all
DIN actuator with 3 independent relays and 2 0-10 V outputs	LG-003519	all	BT-F430R3V10	all

NOTE: In case of several Classe 300EOS with Netatmo units installed in the same house, only one will be able to use the MyHOME Smart Home functions.

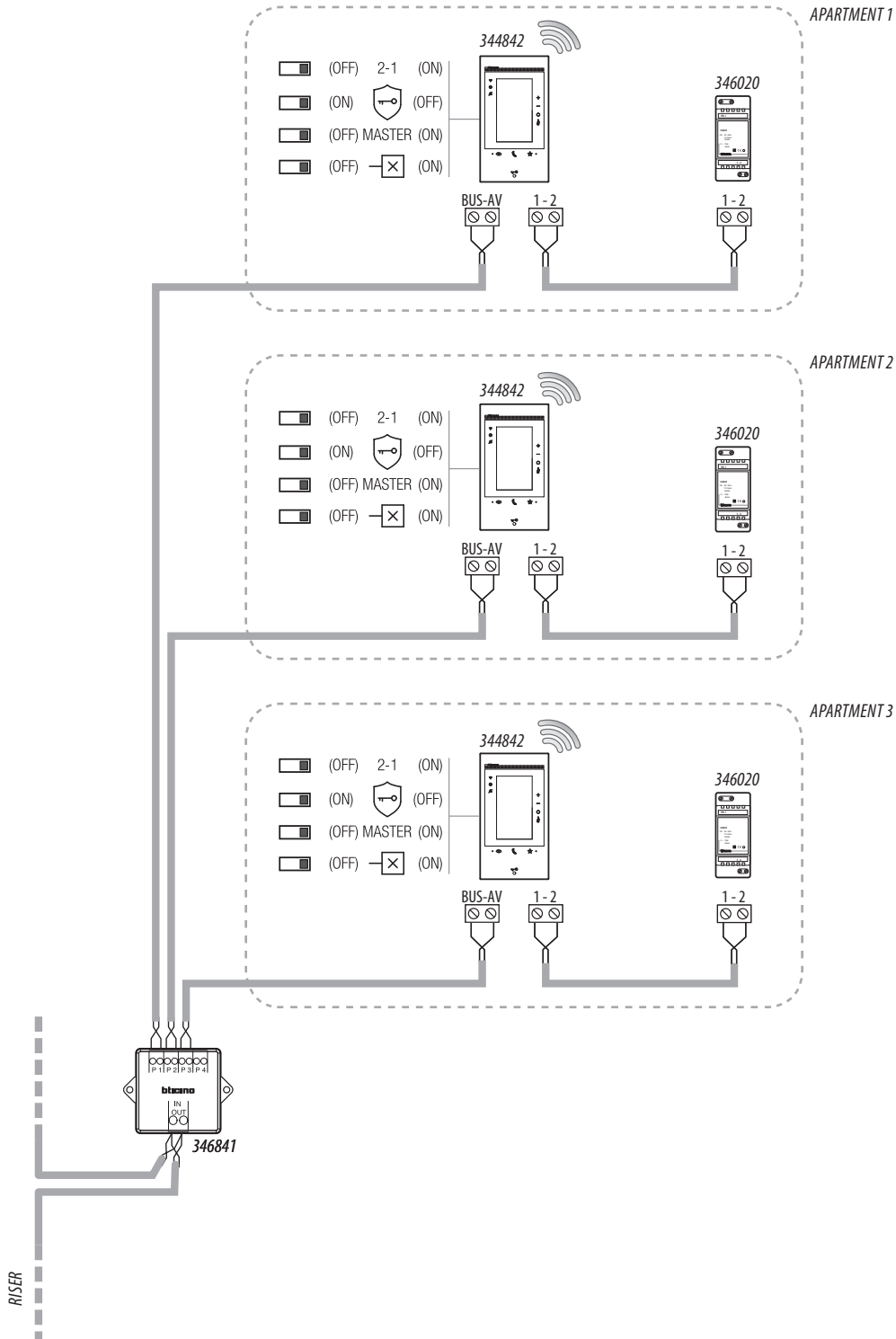
NOTE: The Classe 300EOS with Netatmo is not compatible with the HOMETOUCH device. The HOMETOUCH device is only compatible with MyHOMEServer1.



Wiring diagrams

Below are some examples of connection of the Classe 300EOS with Netatmo 344842 video handset in single family and multi-family 2 wire video door entry systems.

DIAGRAM 1 - EXAMPLE OF MULTI-FAMILY SYSTEM

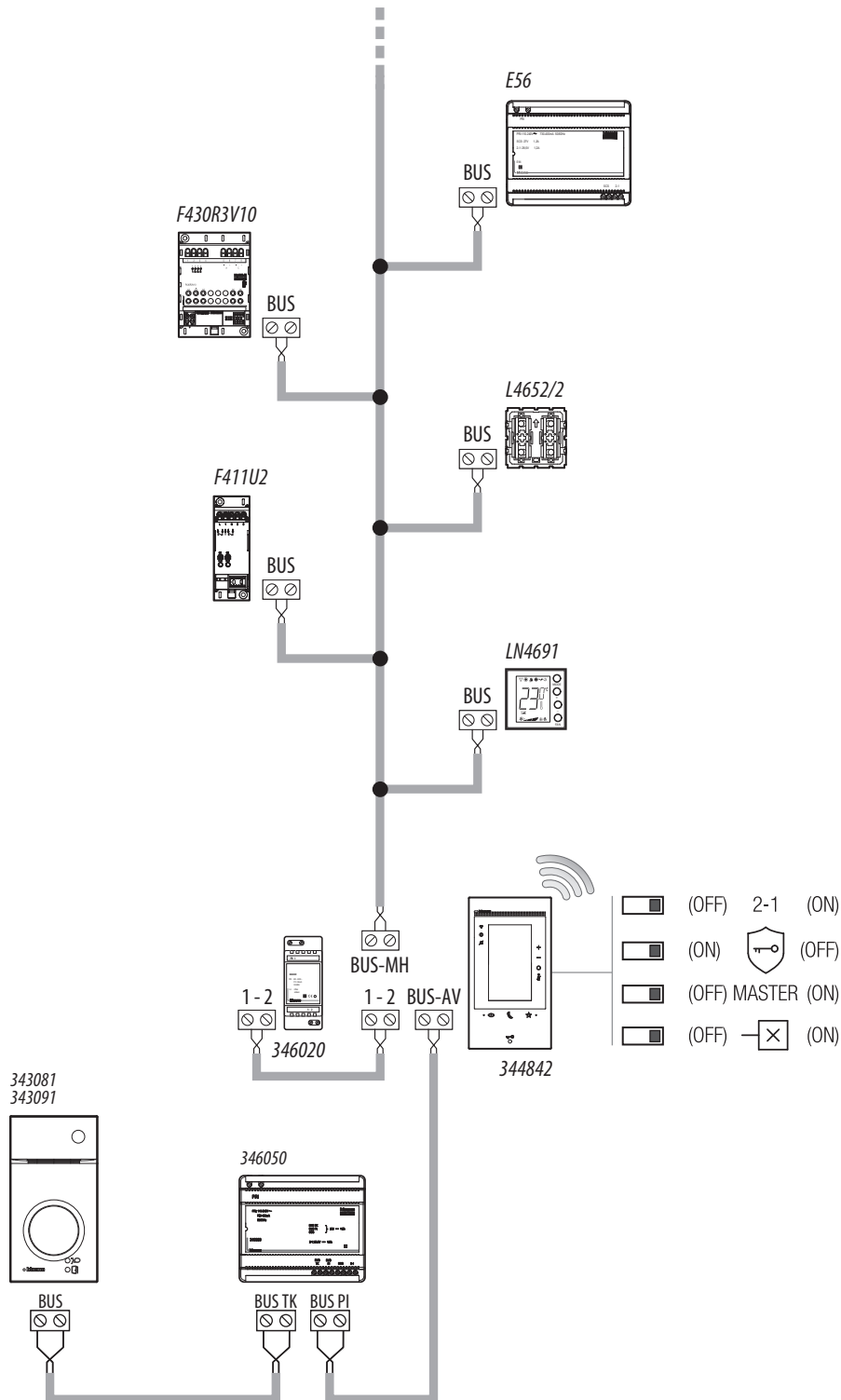


NOTE:

- Additional powersupply is mandatory
- Classe 300EOS with Netatmo has to be installed only in installation tottally 2wire technology
- For other system particularities, refer to the technical guide



DIAGRAM 2 - EXAMPLE OF ONE-FAMILY SYSTEM WITH POWER SUPPLY AND WITH AUTOMATION BUS



NOTE:

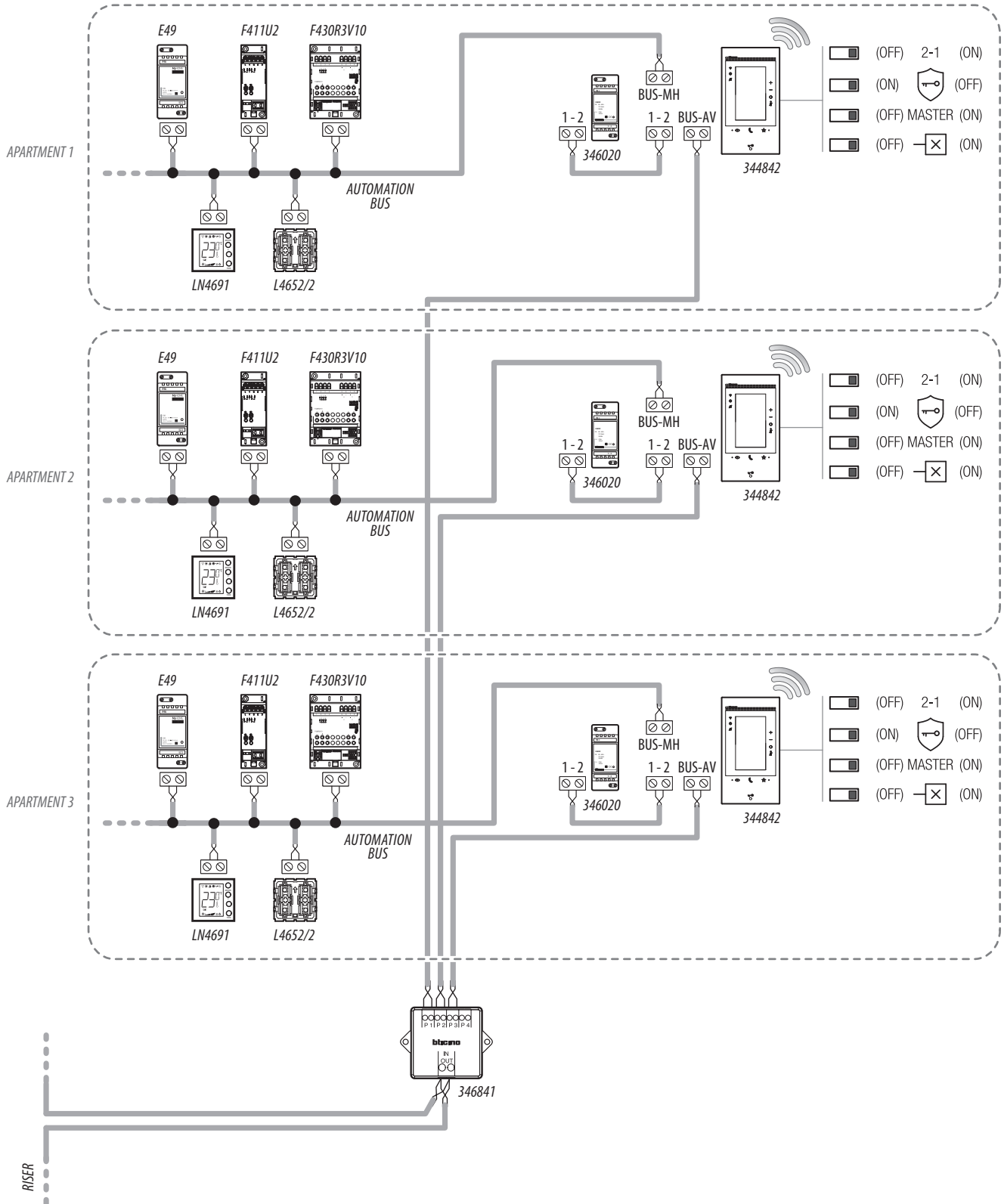
- Additional powersupply is mandatory
- Classe 300EOS with Netatmo has to be installed only in installation tottally 2wire technology
- For other system particularities, refer to the technical guide
- In case of several Classe 300EOS with Netatmo units installed in the same house, only one will be able to use the MyHOME Smart Home functions
- The Classe 300EOS with Netatmo is not compatible with the HOMETOUCH device. The HOMETOUCH device is only compatible with MyHOMEServer1

Class 300EOS with Netatmo touch screen handsfree video internal unit with Wi-Fi

344842



DIAGRAM 3 - EXAMPLE OF MULTI-FAMILY SYSTEM WITH POWER SUPPLY AND WITH AUTOMATION BUS

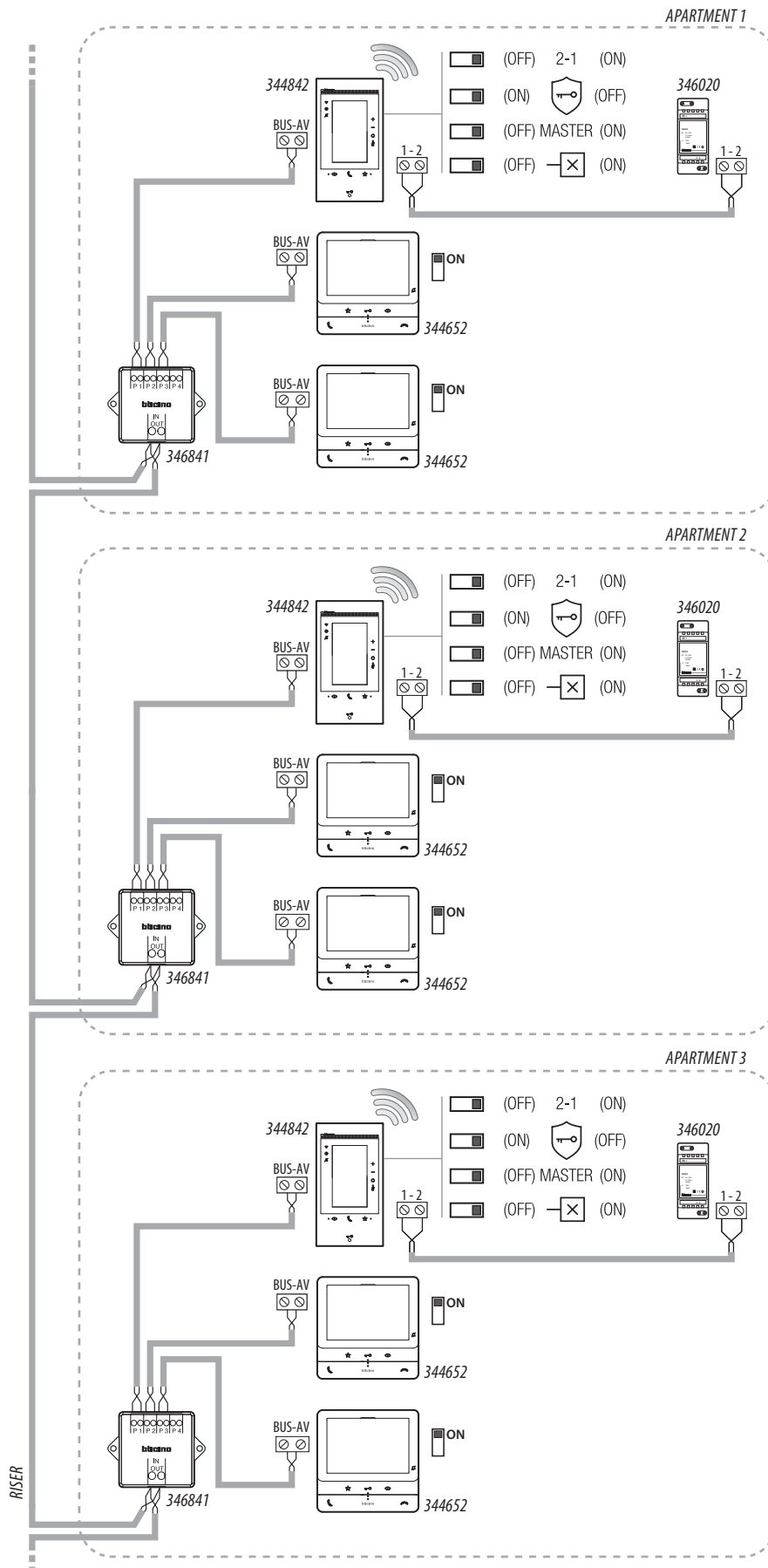


NOTE:

- The additional power supply is mandatory
- Classe 300EOS with Netatmo must be installed only in systems completely made with 2 wires technology
- For other system particularities, refer to the technical guide
- In case of several Classe 300EOS with Netatmo units installed in the same house, only one will be able to use the MyHOME Smart Home functions
- The Classe 300EOS with Netatmo is not compatible with the HOMETOUCH device. The HOMETOUCH device is only compatible with MyHOMEServer1

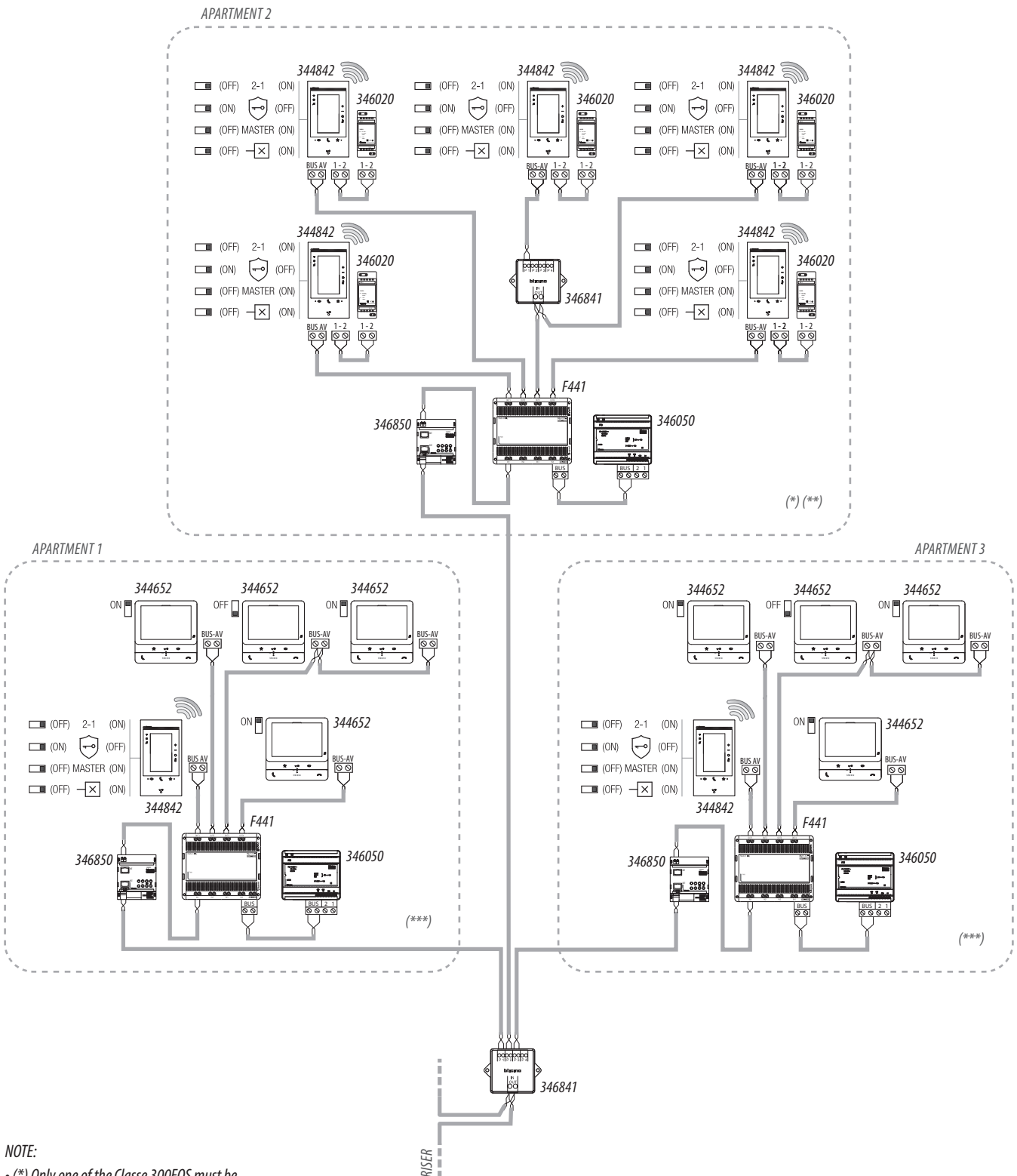


DIAGRAM 4 - EXAMPLE OF MULTI-FAMILY SYSTEM WITH ADDITIONAL INTERNAL UNITS



- NOTE:**
- Additional powersupply is mandatory;
 - Max 3 internal units for apartment;
 - Classe 300EOS with Netatmo has to be installed only in installation tottally 2wire technology.
 - For other system particularities, refer to the technical guide

DIAGRAM 5 – EXAMPLE OF MULTI-FAMILY SYSTEM WITH APARTMENT INTERFACE 346850

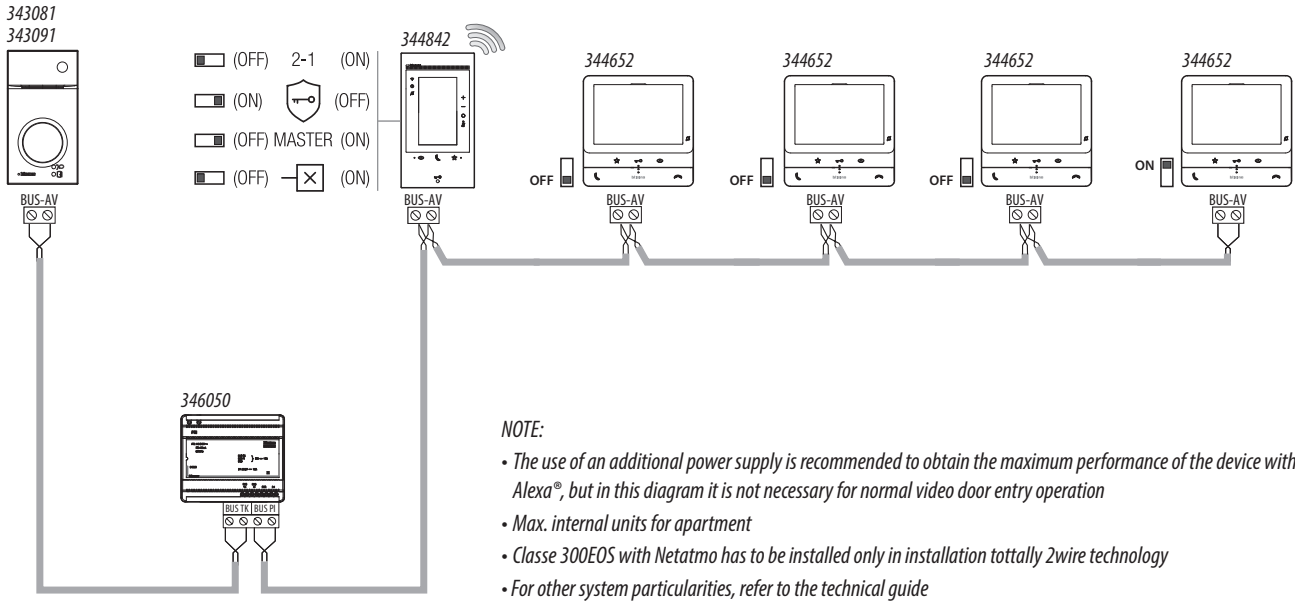


NOTE:

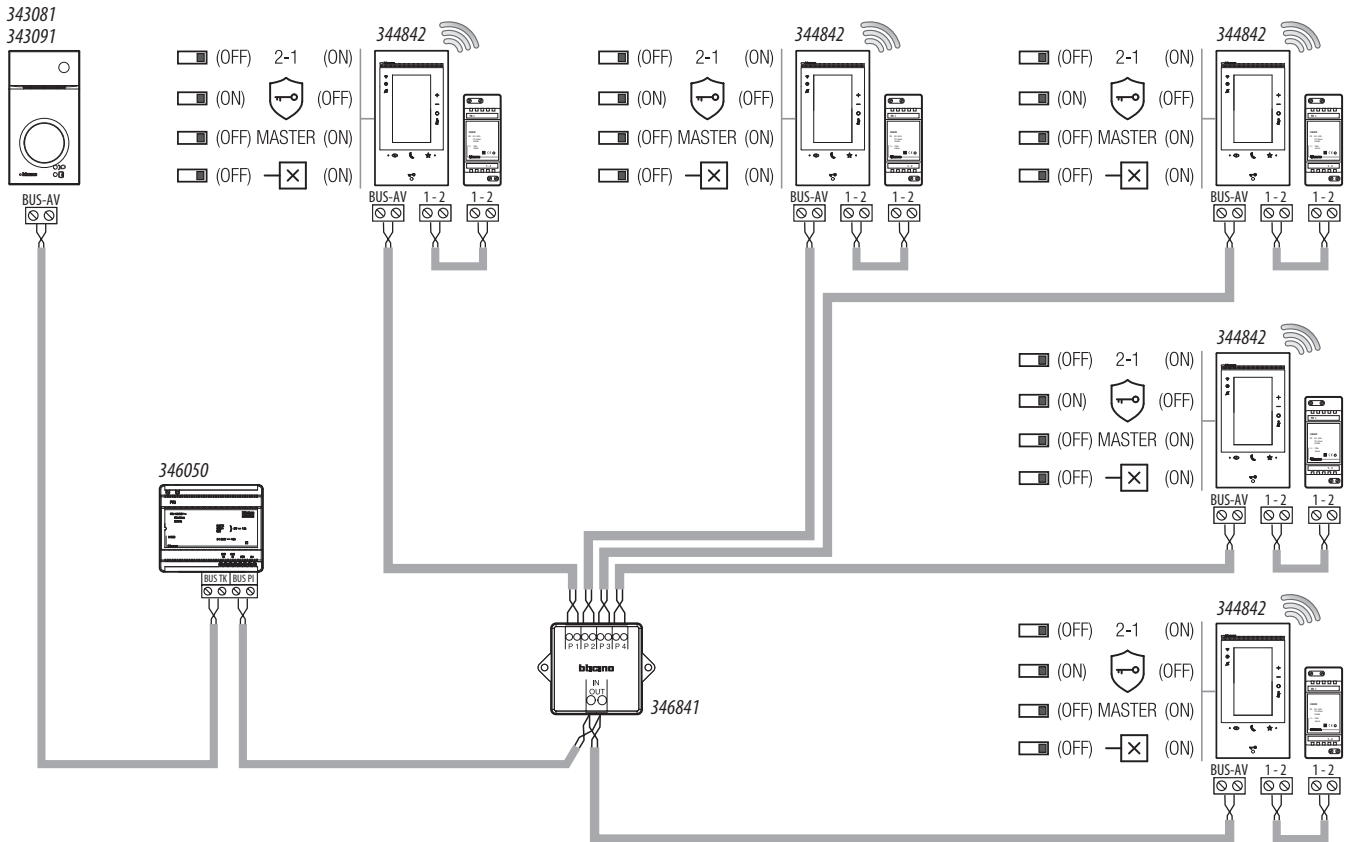
- (*) Only one of the Classe 300EOS must be connected to the Home + Security App
- (**) The additional power supply is mandatory
- (***) The use of an additional power supply is recommended to obtain the maximum performance of the device with Alexa®, but in this diagram it is not necessary for normal video door entry operation
- Max 5 internal units for apartment
- Classe 300EOS with Netatmo has to be installed only in installation totally 2wire technology
- For other system particularities, refer to the technical guide



DIAGRAM 6 - EXAMPLE OF SINGLE-FAMILY DIAGRAM



SCHEMA 7 - EXAMPLE OF SINGLE-FAMILY DIAGRAM WITH 5 CLASSE 300EOS WITH NETATMO

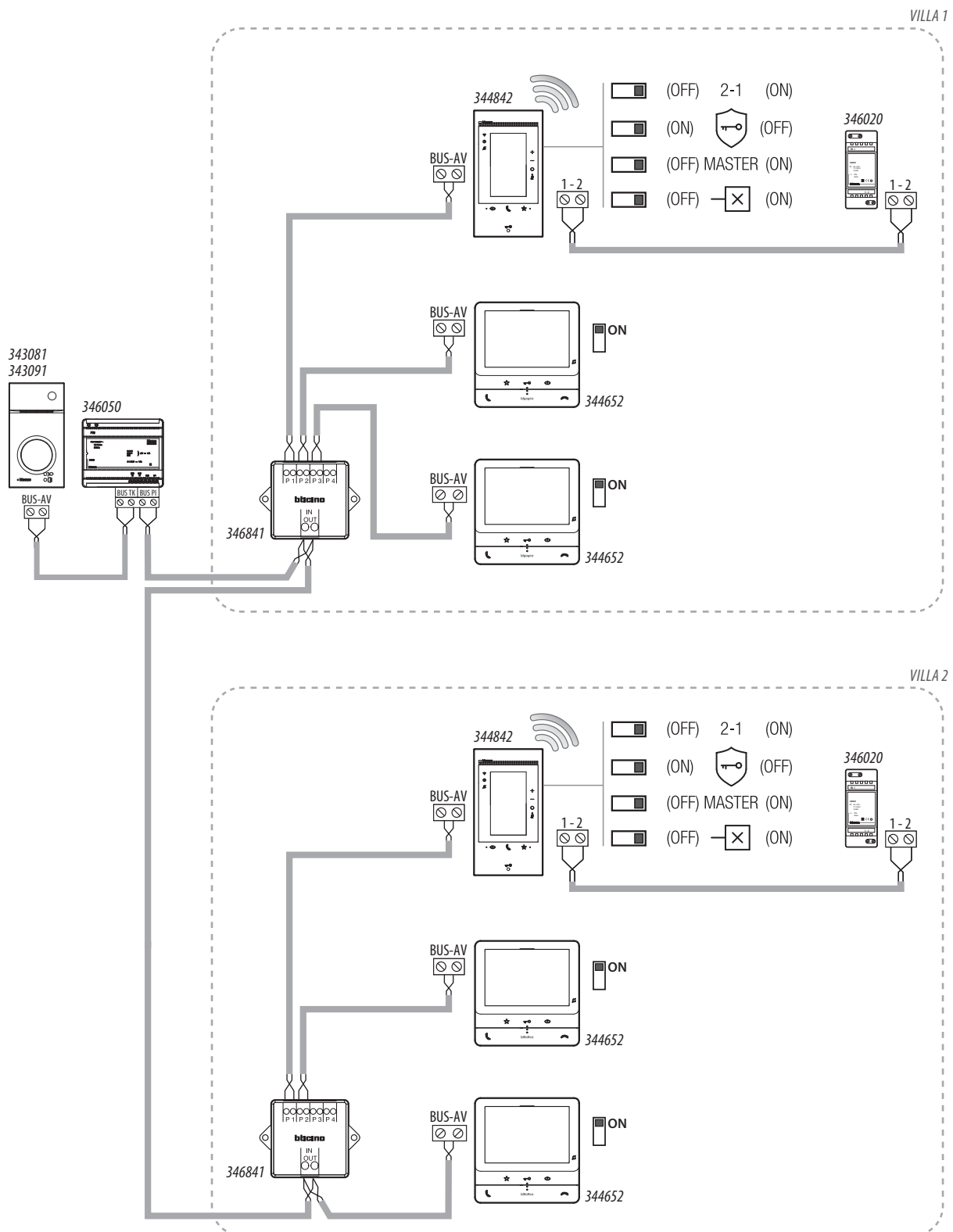


Class 300EOS with Netatmo touch screen handsfree video internal unit with Wi-Fi

344842



DIAGRAM 8 - EXAMPLE OF TWO-FAMILY DIAGRAM



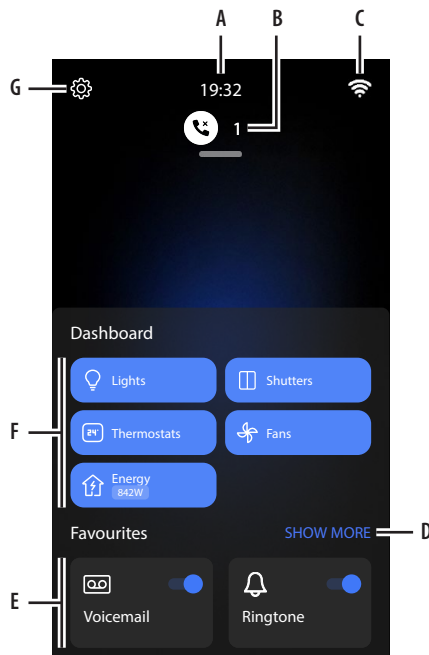
NOTE:

- Max 3 internal units for apartment
- Classe 300EOS with Netatmo has to be installed only in installation tottally 2wire technology
- For other system particularities, refer to the technical guide



Main functions

From the Home Page of the device, it is possible to access the main functions, as described below:



- A **Current time.**
- B **Notifications:** it displays different types of notifications.
- C **Network connection status.**
- D **Favourites:** it opens the section containing the video door entry objects and the MyHome objects that activate the corresponding functions.
- E **Video door entry Favourites highlighted, by default:**
 - Ringtone Exclusion: it mutes the ringtone in case of call.
 - Answering machine: records unanswered entrance panel calls.

It is possible to customise the favourites highlighted, by adding them in the Home Page area, in the section "Add an object to the favourites".
- F **MyHOME function panels:** this area displays some of the MyHOME functions available for controlling the home.

Function panels will only be visible if the installer has included at least one of the objects relating to the function. (e.g.: the light panel will only be visible if the installer has configured a light object).
- G **Settings:** it opens the menu used to customise the functions and thus make the most of the device.

The video handset offers the possibility to select among 6 types of bells with programmed ringtones, which can be freely associated to the following type of calls:

- Call from the entrance panel (configured with S=0)
- Call from the entrance panel (configured with S=1)
- Call from the entrance panel (configured with S=2)
- Call from the entrance panel (configured with S=3)
- Intercom call within the apartment
- Intercom call outside the apartment
- Floor call

The association of the type of ringtone to the event is performed using the dedicated menu on the device.

Using the advanced configuration, the video handset gives the possibility of programming up to:

- 50 generic activations
- 50 direct activations to the door locks
- 40 intercoms within the apartment
- 40 intercoms outside the apartment
- 50 direct auto-switching on to the EP

Video door entry answering machine

The video door entry answering machine allows (if enabled) to display a video message recorded by the visitor.

It is also possible to record an audio message to play back on the entrance panel in case of unanswered call.

Intercom function

The intercom function allows for up to 3-minute communication between and among video door entry systems in the same apartment / in different apartments.

Door state function

This function indicates the status of the door lock (only for systems preset with appropriate actuator). If open the „door lock LED“ flashes, and if closed, the LED stays off. The function cannot be activated together with the Office function.

Office function

The Professional Studio (Office) function gives the possibility of setting the automatic opening of the door lock in case of call from the Entrance Panel. It cannot be activated at the same time as the Door Status and Safe Door Lock functions. The door lock key flashing (🔑) indicates that the functions is active.

MyHOME Smart Home Functions

MyHOME function panels

MyHOME function panels allow to simultaneously control all the lights, shutters and fancoils of the house or individual rooms.

It is also possible to manage thermostats and display the energy consumption of the home.

Simple program

This mode can be used to set different “Day” and “Night” band temperatures.

Example: Set a temperature of 21.5° from 7 a.m. to 10 p.m. and a temperature of 19.5° from 10 p.m. to 7 a.m

MyHOME functions

After the installer has configured the objects in the various rooms and the user has placed them in the Favourites section, it is possible to control the home, for example to switch on the lights or operate the shutters, etc...

MyHOME Function Table

Light Switch a light on and off, or adjust its intensity.	Colored light If the system includes a coloured light (coloured Philips Hue* and Lixf* Enttec ODE* LED lamps), it is possible to adjust its intensity and view its status.
Blind Adjust the opening and the closing of the shutters.	Socket Control the load connected to a controlled socket.
Towel warmer Switch the towel warmer on and off.	Lock It opens a door lock.
Shutter Adjust the opening and the closing of shutters, rolling shutters and garage door.	Scenarios Executes the scenarios set by the installer.

*The device may not be compatible with some models or their firmware versions.